

**Modèle Garde-Corps PANNEAUX DÉCORATIFS**

Échelle : 1:10

**SECTION E**

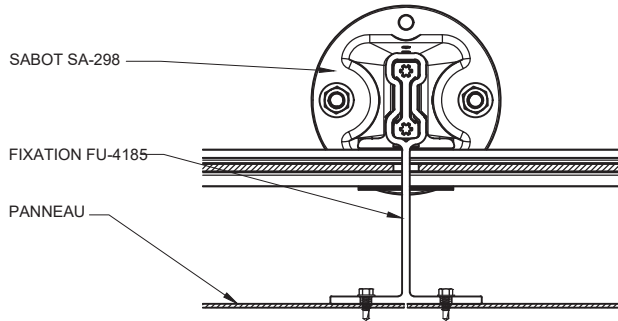
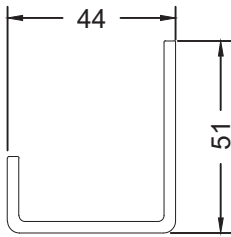
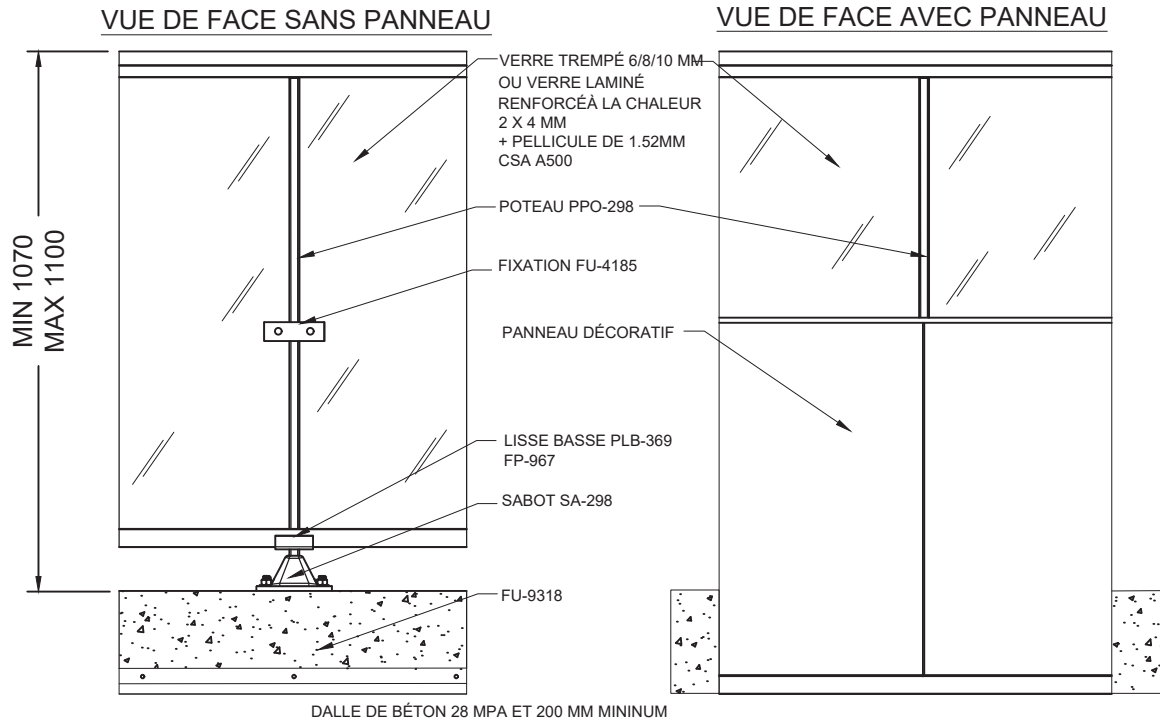

○ DÉTAIL FU-9318  
VUE 1:2

○ DÉTAIL FU-4185  
VUE 1:6

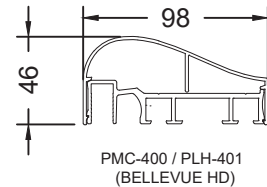
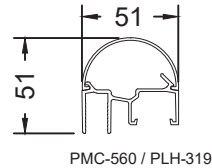
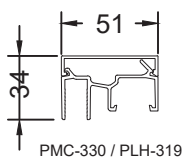
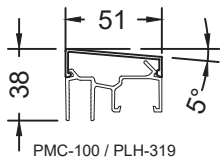

## CHOIX DE MAINS-COURANTES

**Modèle** Garde-Corps PANNEAUX DÉCORATIFS

Échelle : 1:15

SECTION E