

SECTION C

Échelle : 1:8

Modèle **Garde-corps CLASSIQUE Butant**

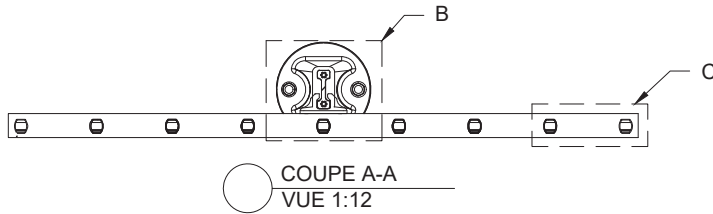

*ESPACE ENTRE LES BARROTINS VARIABLE
VEUILLEZ VALIDER AVEC RAMP-ART*

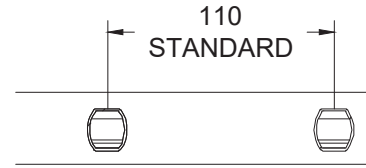

DÉTAIL C
VUE 1:4

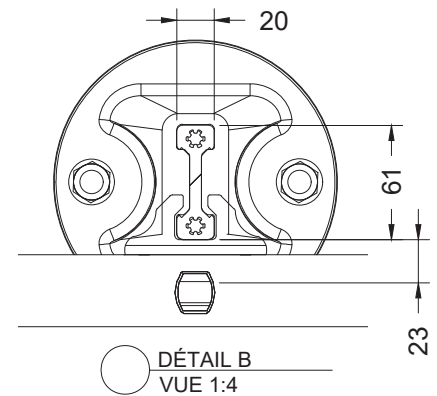
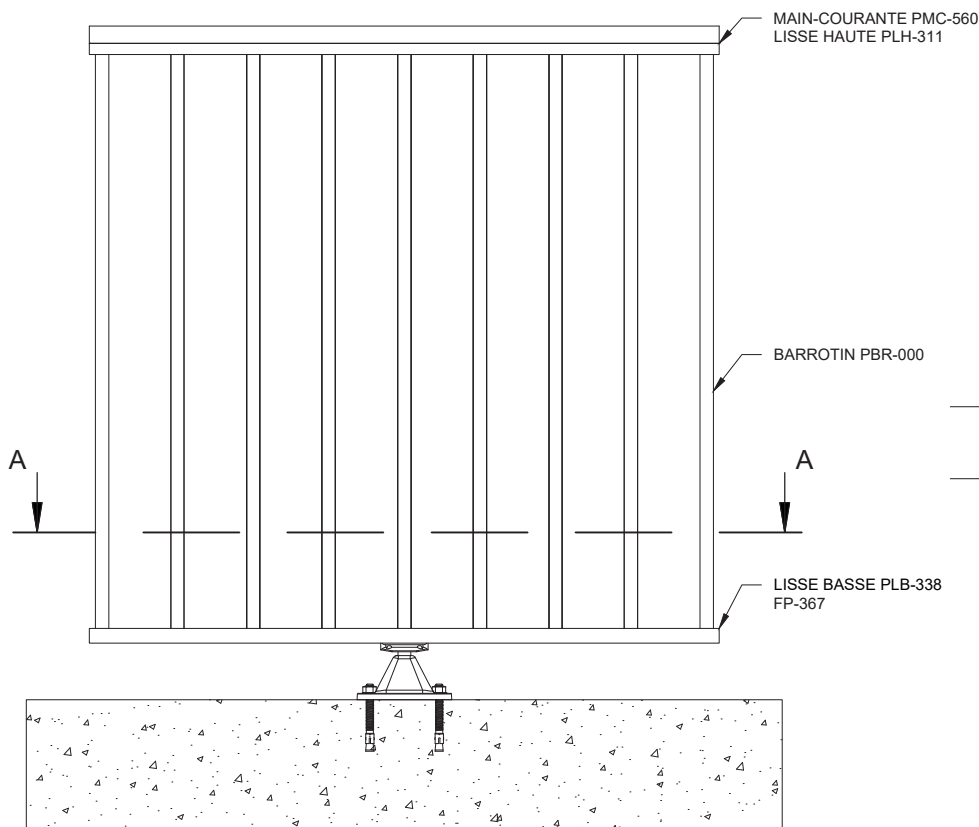

SECTION C

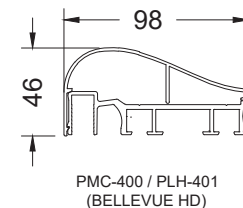
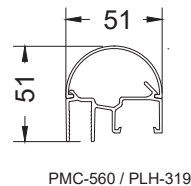
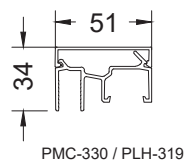
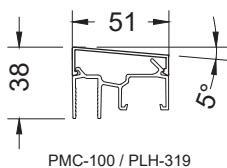

CHOIX DE MAINS-COURANTES

Échelle : 1:12

Modèle **Garde-corps CLASSIQUE Butant**