

Scale 1:5

Model **Guard/Railing BELLEVUE Slab on stud (SA-438)**

**BE298-SA438**

TEMPERED GLASS MIN 6mm

LOWER RAIL PLB-366

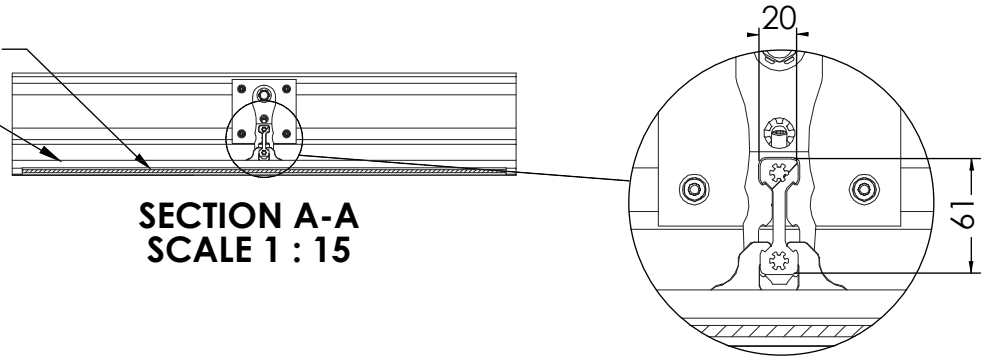

**SECTION A-A**  
**SCALE 1 : 15**

**DETAIL A**  
**SCALE 1 : 4**

HANDRAIL PMC-560  
TOP RAIL PLH-311

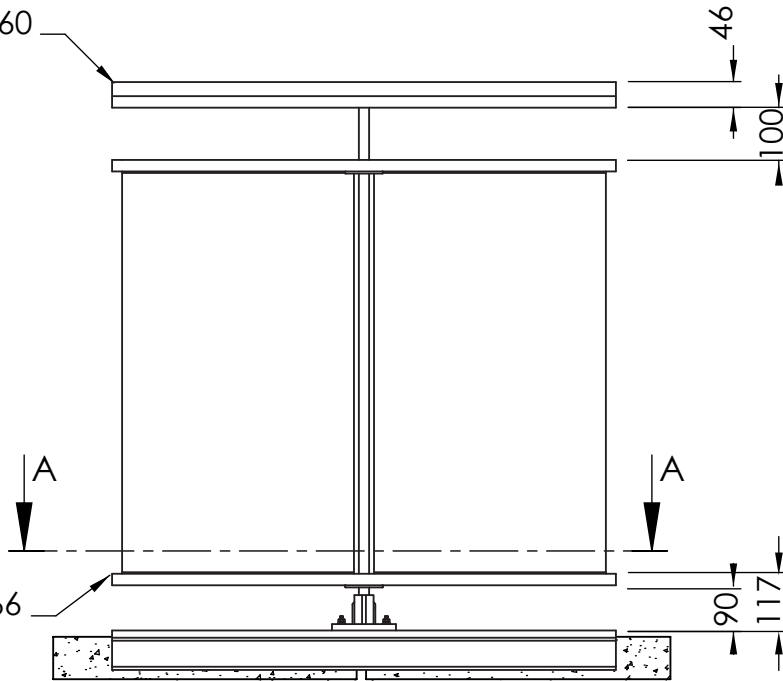

LOWER RAIL PLB-366

**ELEVATION**

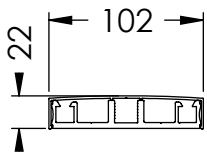

PMC-340

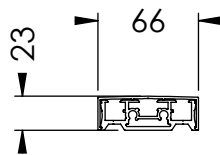

PMC-360

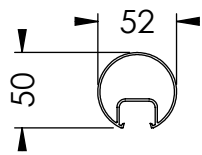

PMC-460

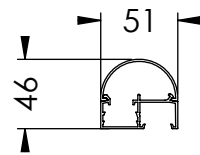

PMC-560

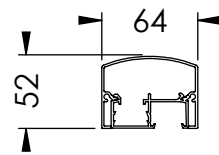

PMC-960

**HANDRAILS**

**Scale 1:15**

Model **Guard/Railing BELLEVUE Slab on stud (SA-438)**

**BE298-SA438**